

Oct 20, 2021

Ver1.03

USB2.0 CMOS CAMERA ARTCAM-265IMX-WOM INSTRUCTION BOOKLET

3.0 M Pixels

ARTCAM-265IMX-WOM Series

ARTRAY CO., LTD.

ARTRAY

Contents

1. Attention	- 3 -
2. Introduction	- 6 -
3. Features.....	- 6 -
4. The Product.....	- 6 -
5. Connections.....	- 7 -
6. Specification.....	- 8 -
6.1. Specifications.....	- 8 -
6.2. Camera's Functions	- 9 -
6.2.1. Shutter Speed.....	- 9 -
6.2.2. Analog + Digital Gain	- 10 -
6.2.3. Black Level Adjustment	- 10 -
6.2.4. Mirror Reversal	- 11 -
6.2.5. Region of Interest (ROI)	- 12 -
6.2.6. Thinning-out (sub-sampling) Settings.....	- 13 -
6.2.7. Trigger Function (Optional)	- 14 -
6.2.8. GPIO	- 16 -
7. Dimensional Outline	- 17 -
7.1. ARTCAM-265IMX-WOM.....	- 17 -
8. Spectral Sensitivity Characteristics (Reference Value)	- 20 -
8.1. ARTCAM-265IMX-WOM (color model)	- 20 -
8.2. ARTCAM-265IMX-WOM (Monochrome Model)	- 20 -
8.3. IR Cut Filter (Color Model only)	- 21 -
8.4. Characteristic of Visible Light Cut Filter.....	- 21 -
9. System Requirements.....	- 22 -
9.1. Recommended System Requirements	- 22 -

1. Attention

■About this manual

1. Before using the camera, please read this manual thoroughly.
2. Please keep this manual reachable and always refer to the contents when needed.
3. Please contact us if the manual is lost or damaged. We will provide a replacement.
4. We cannot guarantee the safety of improper uses of the camera.
5. For your safety, please follow the directions of this manual.
6. All contents are subject to change.
7. Images in this manual may have been simplified to be easier comprehended.
8. Please contact us if you find any unclear points or mistakes in this manual.
9. Quoting, copying or altering some or all parts of the manual without our permission is prohibited.
10. We are not responsible for any lost or damages on your profits due to the use of our products.
11. Please understand that our oversea branches do not provide maintenance or repair services.

■About the Icons

To keep the safety of the user, other people and their properties, please pay attention to the following icons.



Warning

If the user fails to follow the instruction, serious injury or death may occur.



Caution

If the user fails to follow the instruction, physical injury on human or damages on hardware may occur.

■ For Safe Use



Warning

● In following circumstances, please stop using the product and turn off the power immediately to prevent the risks of fires and electric shocks. If the product is defective, please contact us for repair or exchange. For your safety, please do not disassemble, modify or repair the camera on your own.

Please stop using the product and turn off the power immediately when:

- The product becomes smoky or gets extremely hot on the surface, or makes unusual smells or sounds.
- Foreign material or water gets into the product.
- The product falls and becomes damaged.

● Do not place the product on unstable surfaces. The product may be fallen and people may get hurt.



Caution

● Do not expose the product to steam or fumes to avoid electric shocks and fires.

● Do not leave the product in high temperature places such as inside of vehicles or under direct sunlight. High temperature may cause damages to the camera, or even cause fires.

● Do not cover the product with cloth or other materials. The product may get extremely hot and the heat may cause deformations on the parts or even cause fires.

● Please avoid dropping or shocking the product as the product may be damaged.

● Do not touch the cable with a wet hand. Such action may cause electric shocks.

● Please avoid continuously contacting the surface of the camera to your skin when the camera is being used. The surface temperature of the camera may cause burns.

■ Other Notices

● Please do not use the camera under strong lights such as sun light for a long period. Also please do not expose the camera under strong lights even when the product is not being used because the sensor might be damaged.

Maintenance

● Wipe the dirt on surface with soft cloth or tissue paper. Do not use alcohol, thinner or benzene to avoid damaging the surface paints.

Electro Magnetic Interference

●The camera may interfere with electronic devices such as TV and radio. Please do not place the camera next to such equipment.

■Export Control

This product is a Catch-all Control item subject to the Foreign Exchange and Foreign Trade Act and its relevant legislations. Except for exporting to the 26 white countries designated in the Cabinet Order, export licenses are required if the products are going to be used for military use or if the end user of the product is related to all kinds of military activities. If your circumstances cause the need to apply export licenses, please notify us before you place orders. Also, please notify us in advance if the end users or purposes of use change after the purchase and thus cause the need to apply export licenses.

About the Japanese Security Export Controls, please refer to the webpage for Security Export Control Policy, the Ministry of Economy, Trade and Industry:

www.meti.go.jp/policy/anpo/englishpage.html

The above is based on the enforcement laws and regulations at the time of issuance of this document. Please be sure to check the latest laws and regulations before actually exporting this product.

■Guarantee

To save the environment, we do not issue warranty in printed format. Instead, all records of the warranty periods, delivery dates and the customer information are well kept in our system.

For more details, please refer to the following link:

Hardware Warranty: http://www.artray.us/download/artray_warranty.pdf

●We do not guarantee the functions of this product or the descriptions on this manual to be completely adapted to the users' end applications or marketing purposes. We are also not held responsibility for any direct or indirect damages caused by our products under any circumstances.

●Please do not use this product for a task that require high reliability. This product is not manufactured to be used as medical, nuclear, aerospace, transportation equipment or equipment or that is highly related to human safety. We are not held responsibility for any damages on the users' property, equipment or personal safety caused by this product.

■Disposal

●To dispose this product, please return the camera to us. If you decide to dispose the camera without returning it to us, please follow related regulations and have the camera disposed as an industrial waste. Please always keep track of the disposal, and make sure the disposed camera cannot be accessed or used by any third party.

2. Introduction

ARTCAM-265IMX-WOM series are USB2.0 CMOS cameras that designed for industrial use. Adopting USB2.0 interface, thus enables direct data transfer to PC without a capture card.

3. Features

- USB2.0 Interface

Adopting USB2.0 interface, thus enables direct data transfer to PC without a capture board or a host adapter card.

- Global Shutter

The CMOS sensor uses Global Shutter, therefore even high-speed moving objects can be clearly shot without distortion.

- Included Viewer Software

ART-Viewer (Windows 7/8/10).

Users can easily preview, save images and change camera settings by ART-Viewer.

- Included Software Development Kit

When developing image processing software, a software development kit that enables you to acquire Camera image acquisition and camera control are possible with other applications is included as standard.

You can also download it from the website below.

http://www.artray.us/download_sdk.html

- 2D Measurement & Filing Software(Optional)

Useful 2D measuring functions are available with the optional 2D Measuring & Filing Software - ART-MEASURE.

4. The Product

- 1) Camera
- 2) USB2.0 Cable (USB2.0 A to micro B Type 3.0m)
- 3) Viewer software and Device driver CD

<Option>

- 1) C Mount Lens
- 2) 2D Measurement & Filing Software <ART-MEASURE>
- 3) Software Development Kit [ARTCCM-SDK]
- 4) USB extension cable with repeater function (5.0m)

5. Connections

Please connect the camera and the PC by using the attached USB2.0 cable.
Camera's power is supplied from USB Bus Power.

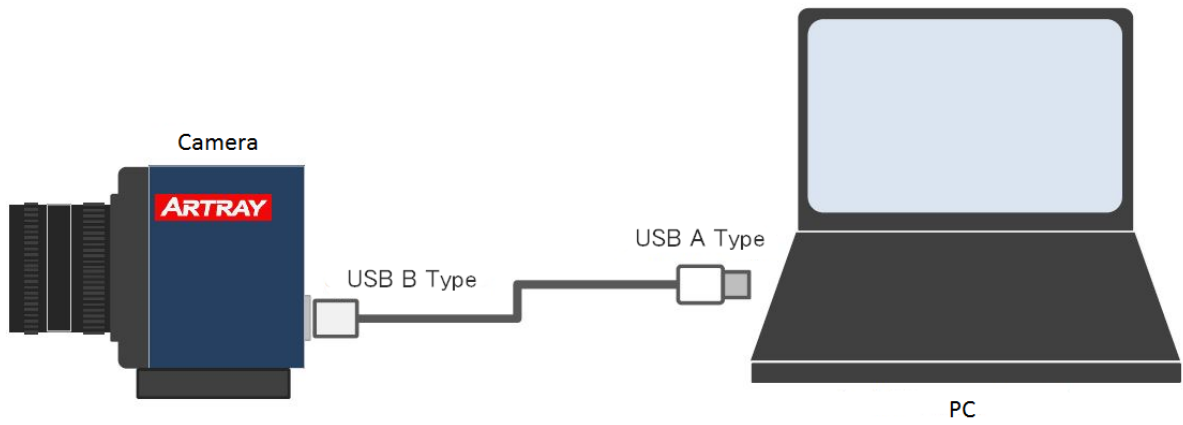

6. Specification

6.1. Specifications

Items	COLOR	MONOCROME
Model	ARTCAM-265IMX-WOM	ARTCAM-265IMX-BW-WOM ARTCAM-265IMX-NIR-WOM
Sensor Type	CMOS Image Sensor	
Model Number	IMX265LQR-C	IMX265LLR-C
Total number of pixels	2064 (H) x 1554 (V)	Approx. 3.21MP
Active Pixels	2064 (H) x 1544 (V)	Approx. 3.19MP
Number of execution pixels	2064 (H) x 1544 (V)	Approx. 3.19MP
Recommended number of recording pixels	2048 (H) x 1536 (V) 1920 (H) x 1080 (V)	Approx. 3.15MP All pixels Approx. 2.07MP 1080p-Full HD
Active Image Size	7.12 (H) × 5.33 (V) mm, 1/1.8 Inch	
Scanning mode	Progressive Scan	
Pixel Size	3.45 (H) × 3.45 (V) μm	
Shutter	Global Shutter	
Color Filter Array	RGB Bayer Pattern	Monochrome Pattern
Synchronization Method	Internal Synchronization (preview mode) External Synchronization (Trigger mode)	
A/D resolution	12bit	
Interface	USB2.0 Bulk Transfer	
Lens Mount	C Mount	
Frame Rate	Max 12.0 fps (8bit) Max 6.0 fps (12bit)	
Exposure time	1/21941 sec. ~ 1.49 sec.	
Power-supply Voltage	5.0V (±0.5V) USB Bus Power	
Power Consumption	Approx. 2.5W	
Ambient Conditions	Operating Temperature / Humidity: 0~35° C / 10~80% (Non-water vapor condensation state) Storage Temperature / Humidity: 0~60° C / 10~95% (Non-water vapor condensation state)	
External Dimensions	50.0(W) × 47.0(H) × 49.7(D) mm *Exclude lens, tripod mount and projections	
Weight	Approx. 140 g * Not include lens, tripod mount, and cable	

6.2. Camera's Functions

6.2.1. Shutter Speed

The exposure time (electronic shutter speed) of the camera can be set in 100 μ sec unit (1 line time resolution).

The exposure time can be calculated by the following formula:

$$\text{Exposure time} = \text{the setting value of the shutter speed} * 100 \mu \text{ sec (Setting Range: } 1 \sim 32767)$$

When outputting all pixels (2048 x 1536), it follows:

$$1 \text{ line time} = (2048 + 208) * 1.5 * 1/74.25 [\mu \text{ sec}] = 3384 * 1/74.25 [\mu \text{ sec}] = 45.575 [\mu \text{ sec}]$$

$$\text{Exposure time (min)} = 1 * 45.575 [\mu \text{ sec}] = 45.575 [\mu \text{ sec}]$$

$$\text{Exposure time (max)} = 32767 * 45.575 [\mu \text{ sec}] = 1.49 [\mu \text{ sec}]$$

When setting to ROI mode, it follows:

$$1 \text{ line time} = (\text{Effective horizontal pixels} + 208) * 1.5 * 1/74.25 [\mu \text{ sec}]$$

When setting to thinning-out (sub-sampling) mode, it follows:

$$1 \text{ line time} = (2048 + 208) * 0.75 * 1/74.25 [\mu \text{ sec}] = 1692 * 1/74.25 [\mu \text{ sec}] = 22.787 [\mu \text{ sec}]$$

$$\text{Exposure time (min)} = 1 * 22.787 [\mu \text{ sec}] = 22.787 [\mu \text{ sec}]$$

$$\text{Exposure time (min)} = 32767 * 22.787 [\mu \text{ sec}] = 746.69 [\text{msec}]$$

※If ROI or thinning setting is changed, the light time will change and the image brightness will change. If you are using SDK, you can use the Set/GetRealExposure function to set/get the exposure time in 1 μ sec units.

※If the frame rate does not improve despite to ROI or thinning-out transfer mode, The exposure time setting value may be larger than effective vertical pixels. In that case, please set exposure time to < effective vertical pixels.

6.2.2. Analog + Digital Gain

Analog gain and digital gain are installed in the sensor of this camera.

For the set value [0~480] of the software, the floating range of the gain magnification changes from 0.0 dB to 48.0 dB.

Formula for calculating the gain magnification:

$$\text{Gain [dB]} = \text{Gain's set value} / 10.0 \text{ [dB]}$$

When the setting value is over 240, the digital gain data becomes valid.

The relationship between gain set value and magnification [dB] is shown as below:

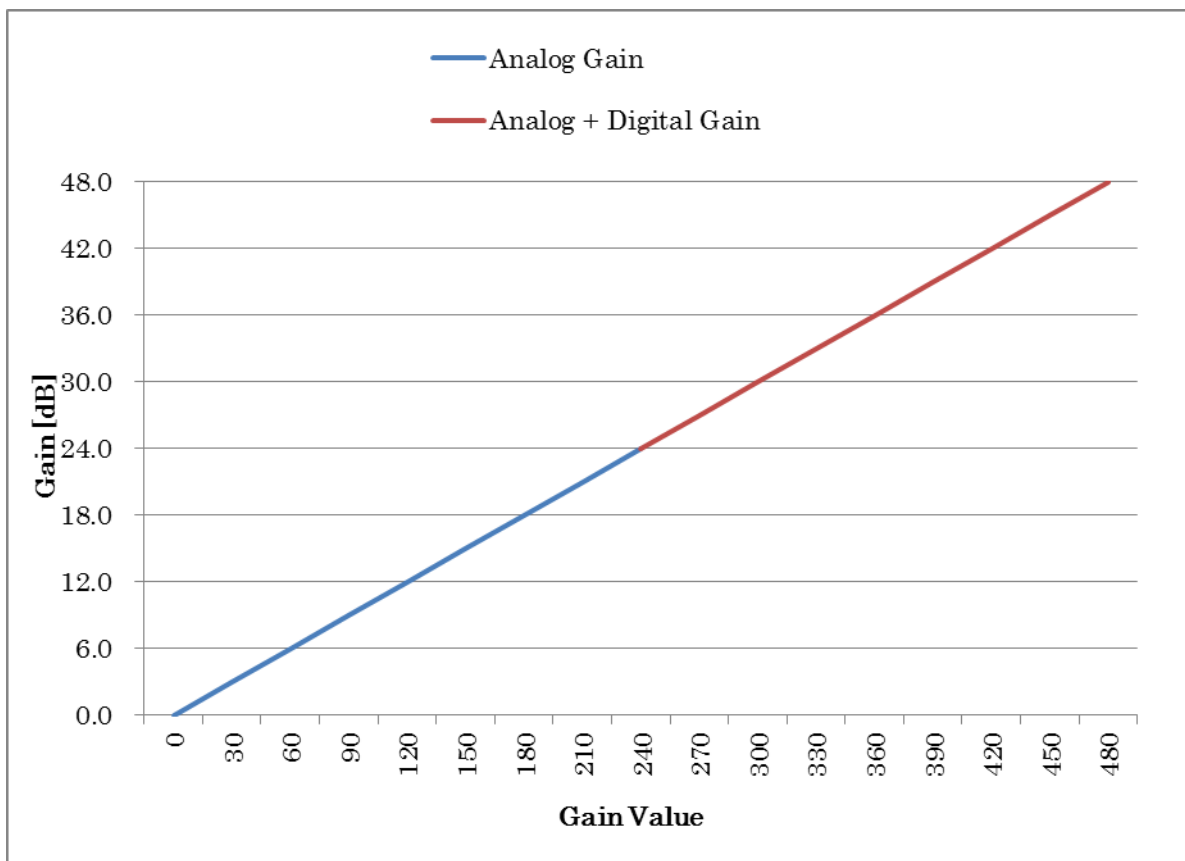

6.2.3. Black Level Adjustment

As for this camera, offset of the Black level is added to the data where the digital gain is applied. The initial set value of the black level is 80 when outputting 12bits.

Therefore, the luminosity value in a light shaded state will be around 5 when outputting 8 bits (or 24 bits color).

※If you wish to change this value, please contact our sales department.

6.2.4. Mirror Reversal

The sensor utilized in this camera provides horizontal and vertical mirror reversal function.

In a normal position (of no avail to both horizontal reversal and vertical reversal), the lower left corner of the direction in which the front of the camera is oriented is the origin (0, 0).

When horizontally or vertically reversed, the Bayer setting of the software will be automatically converted.

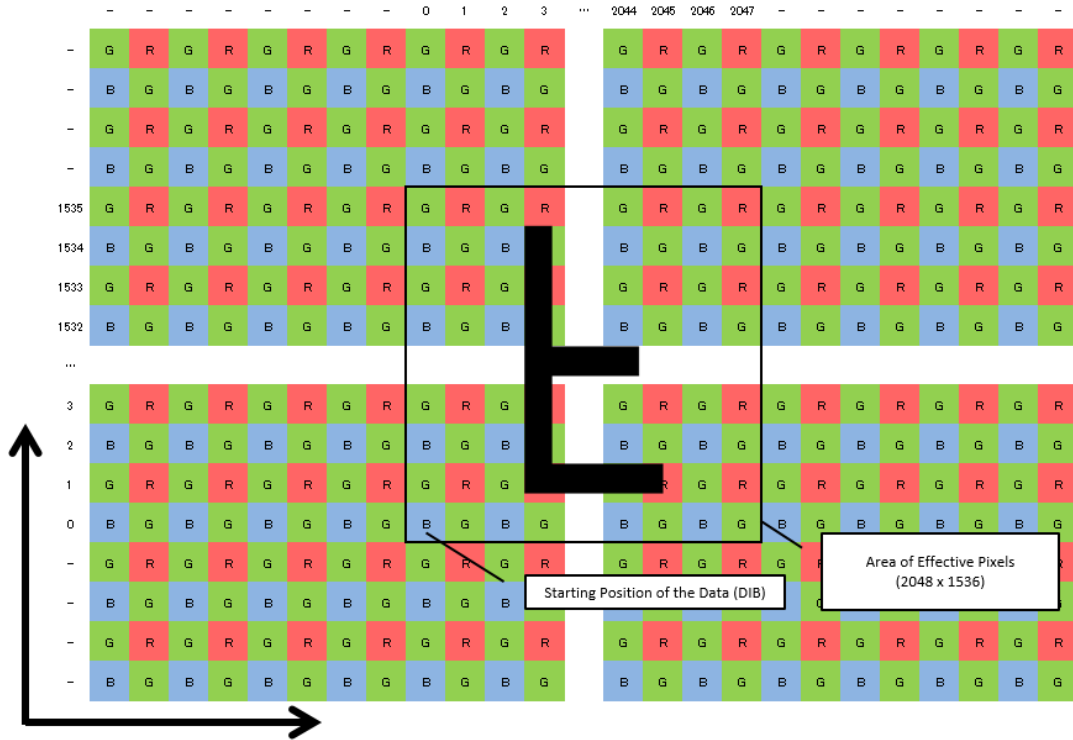

The positional relationship on the optical surface

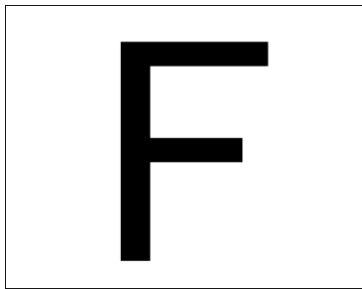

Display on a PC

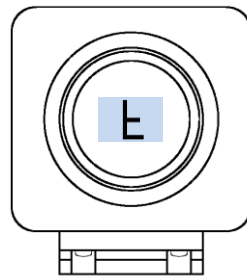

Up and down position of the camera

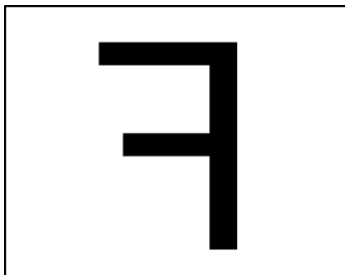

Effective horizontal reversal

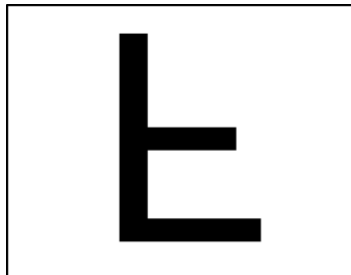

Effective vertical reversal

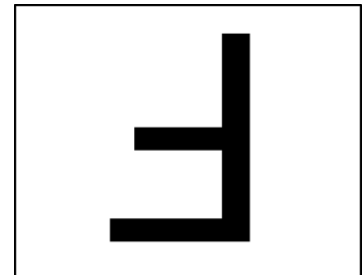

Effective vertical and horizontal reversal

6.2.5. Region of Interest (ROI)

It is possible to reduce unnecessary data as well as increasing frame rate by cutting out an arbitrary area in the effective pixel scope.

The arbitrary area can be simply cut by specifying "starting point" and "effective pixels".

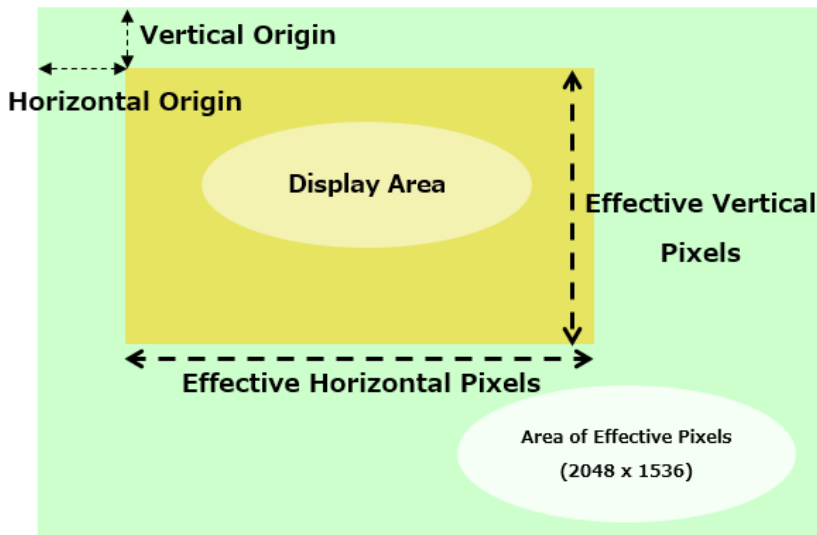

※The above image shows the positional relationship with the origin (0,0) in the upper left corner.

Please specify the "origin" by selecting the location of Effective Horizontal Origin and the Effective Vertical Origin.

Please specify the "Effective Pixels" by selecting the Effective Vertical Pixels and the Effective Horizontal Pixels.

Please use multiples of 4 when specifying values.

The range of values of the horizontal direction is 320~2048, and the range of values of the horizontal direction is 4~1536.

For instance, if specify the effective horizontal starting point as 128, the effective vertical starting point as 64, the effective horizontal pixel as 1280, and the effective vertical pixel as 640, then the cut area is shown as below. In such a case, the frame rate is around 129fps (reference value).

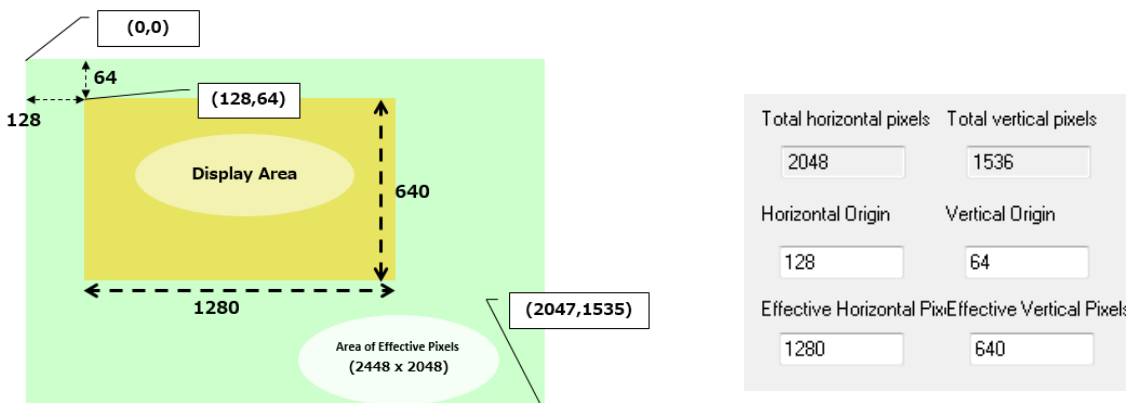

6.2.6. Thinning-out (sub-sampling) Settings

This is a function to reduce the total amount of transfer data and improve the frame rate by skip reading pixels.

This sensor supports horizontal/vertical 1/2 thinning-out mode.

As the figure below, by skip reading pixels while leaving the Bayer pattern, the color information will not lost.

	0	1	2	3	4	5	6	7	8	9	10	11	...	2036	2037	2038	2039	2040	2041	2042	2043	2044	2045	2046	2047
1535	G	R	G	R	G	R	G	R	G	R	G	R		G	R	G	R	G	R	G	R	G	R	G	R
1534	B	G	B	G	B	G	B	G	B	G	B	G		B	G	B	G	B	G	B	G	B	G	B	G
1533	G	R	G	R	G	R	G	R	G	R	G	R		G	R	G	R	G	R	G	R	G	R	G	R
1532	B	G	B	G	B	G	B	G	B	G	B	G		B	G	B	G	B	G	B	G	B	G	B	G
1531	G	R	G	R	G	R	G	R	G	R	G	R		G	R	G	R	G	R	G	R	G	R	G	R
1530	B	G	B	G	B	G	B	G	B	G	B	G		B	G	B	G	B	G	B	G	B	G	B	G
1529	G	R	G	R	G	R	G	R	G	R	G	R		G	R	G	R	G	R	G	R	G	R	G	R
1528	B	G	B	G	B	G	B	G	B	G	B	G		B	G	B	G	B	G	B	G	B	G	B	G
...																									
7	G	R	G	R	G	R	G	R	G	R	G	R		G	R	G	R	G	R	G	R	G	R	G	R
6	B	G	B	G	B	G	B	G	B	G	B	G		B	G	B	G	B	G	B	G	B	G	B	G
5	G	R	G	R	G	R	G	R	G	R	G	R		G	R	G	R	G	R	G	R	G	R	G	R
4	B	G	B	G	B	G	B	G	B	G	B	G		B	G	B	G	B	G	B	G	B	G	B	G
3	G	R	G	R	G	R	G	R	G	R	G	R		G	R	G	R	G	R	G	R	G	R	G	R
2	B	G	B	G	B	G	B	G	B	G	B	G		B	G	B	G	B	G	B	G	B	G	B	G
1	G	R	G	R	G	R	G	R	G	R	G	R		G	R	G	R	G	R	G	R	G	R	G	R
0	B	G	B	G	B	G	B	G	B	G	B	G		B	G	B	G	B	G	B	G	B	G	B	G

When using it in combination with ROI setting, specify the starting point and effective pixel number before thinning out in ROI setting.

* Also, if both ROI and thinning are set due to the specifications of the sensor, the improvement in frame rate by ROI will be invalid.

6.2.7. Trigger Function (Optional)

ARTCAM-265IMX-WOM series are designed with external trigger.

Input a pulse signal of 5 to 12V voltage level to the BNC terminal on the back of the camera case. The trigger input signal is input to the FPGA via the photocoupler inside camera, then the rising edge of the signal is detected in FPGA, based on that timing, output waveform will be formed in the FPGA and send to the sensor.

Trigger Input Circuit

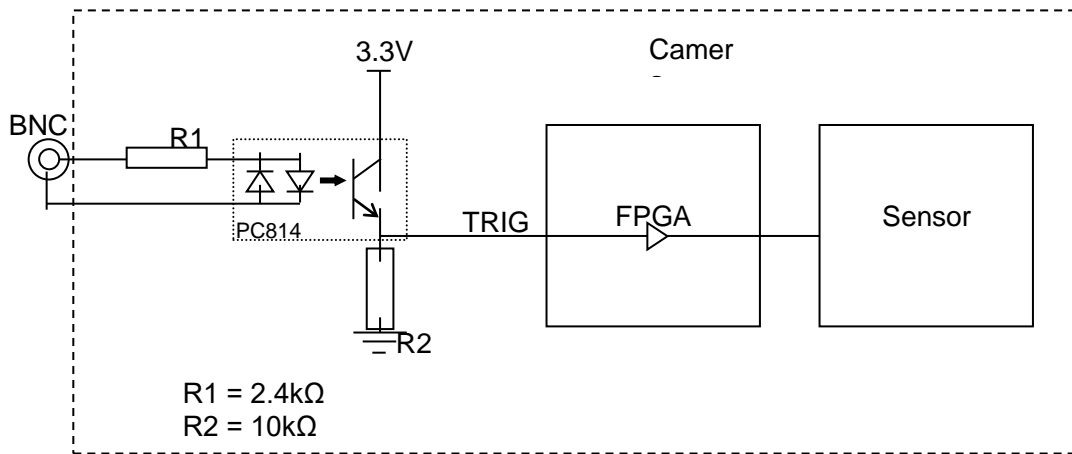

Trigger Timing Chart

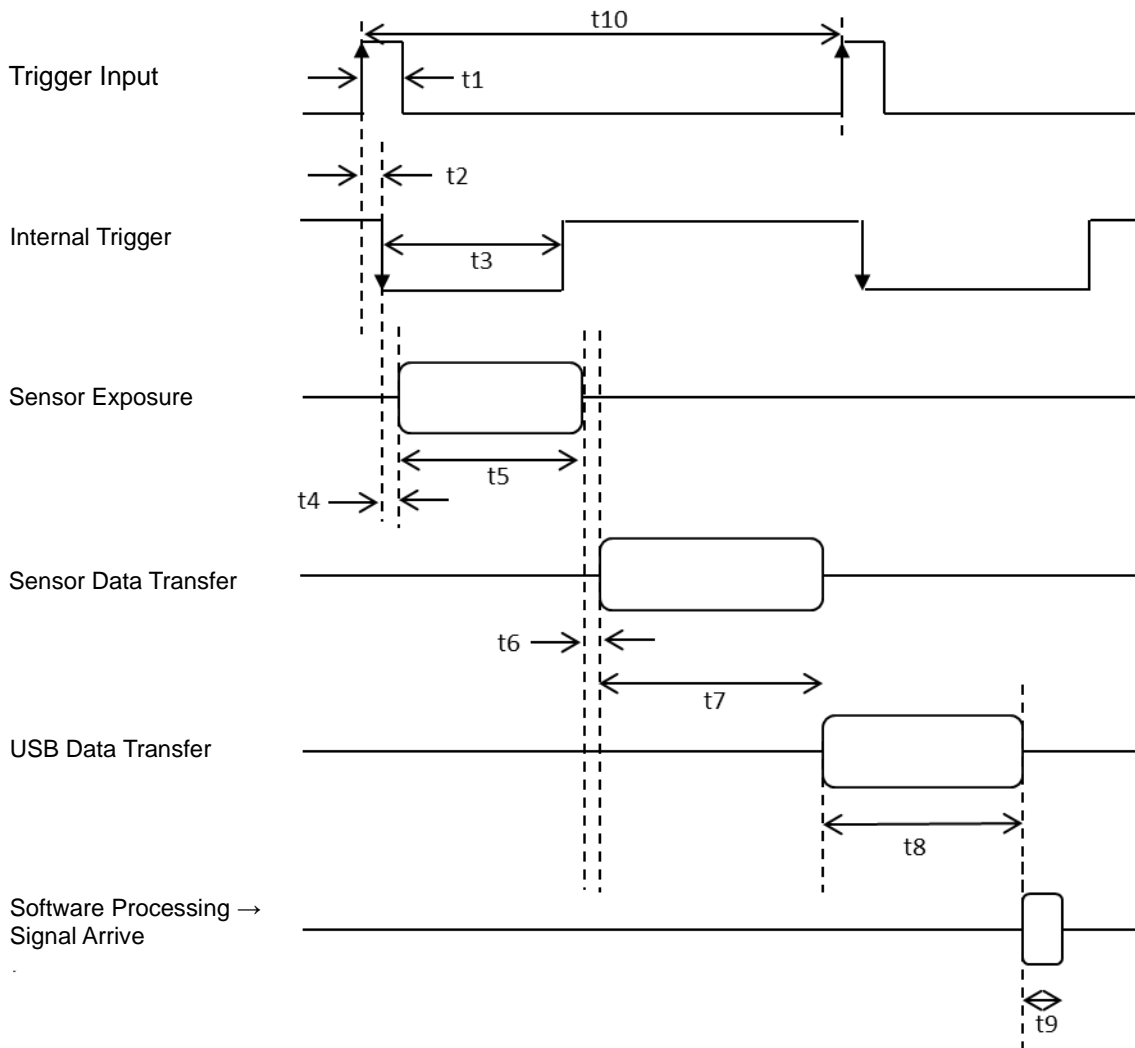

t1	Input Pulse Width	Above $10 \mu s$
t2	Trigger rising while internal trigger signal falling	$2 \mu s$ or less
t3	Internal trigger signal pulse width (= exposure Time)	The FPGA emits a pulse width that is approximately the same as the light time set in the sensor.
t4	Sensor pixel reset period	2-3 line time (1 line time = $3384 * 1/74.25 [\mu sec]$)
t5	Exposure time	$t3 + 13.73 \mu s$ Length of t3 depends on the shutter speed setting value (Light time = Shutter speed setting value * 1 line time)
t6	From exposure end to data transfer	19 line time - $13.73 \mu m \approx 852 \mu m$
t7	Data transfer (sensor to FPGA)	1536 line time $\approx 70 ms$
t8	Data transfer (sensor to USB→PC)	Depends on the USB transfer speed (Standard speed is about 78 ms)
t9	Software processing time	About 10ms (depends on CPU speed and process content)
t10	Valid trigger acceptance interval	$t3 + 1580$ line time (about 72 ms)

6.2.8. GPIO(Optional)

GPIO option is available upon request before the delivery of the ARTCAM-265IMX-WOM series.

Each of the six GPIO pins is pulled up to 3.3V with 1k Ω on the circuit board and is connected to the IO pins on FPGA.

The IO port of the FPGA complies with 3.3V LVCMOS standard.

Pin assign

No.	Function
1	GPIO_0
2	GPIO_1
3	GPIO_2
4	VCC(3.3V) Maximum output 50mA
5	GPIO_3
6	GPIO_4
7	GPIO_5
8	Gnd

GPIO's standard functions include switching the specified port's output (High/Low) and reading the specified port's input (High/Low).

(* FPGA port becomes Hi-z output when High output and High output will be complied by pull-up resistor.)

These can be controlled by the Set/GetIOPort function of SDK.)

Monitoring the vertical synchronization signals, horizontal synchronization signals, strobe signals, and trigger signals on the sensor are possible as extensions of the GPIO option. (Optional)

In addition, it is possible to customize the PWM signal output for LED control and data transmission / reception by SPI communication. Please contact us for details of each function.

7. Dimensional Outline

7.1. ARTCAM-265IMX-WOM

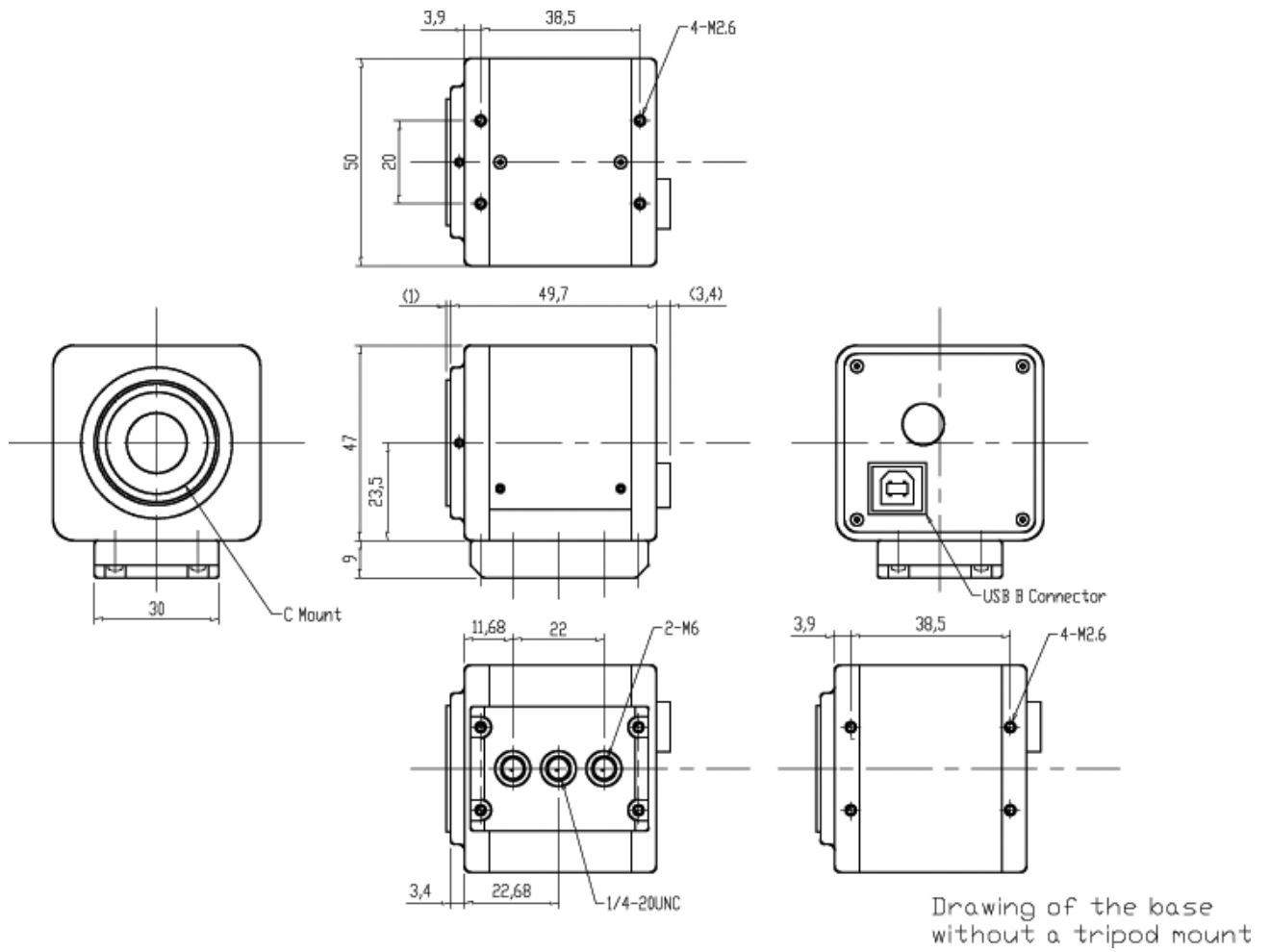

Illustrations of the relationship between the Mount and the Sensor surface

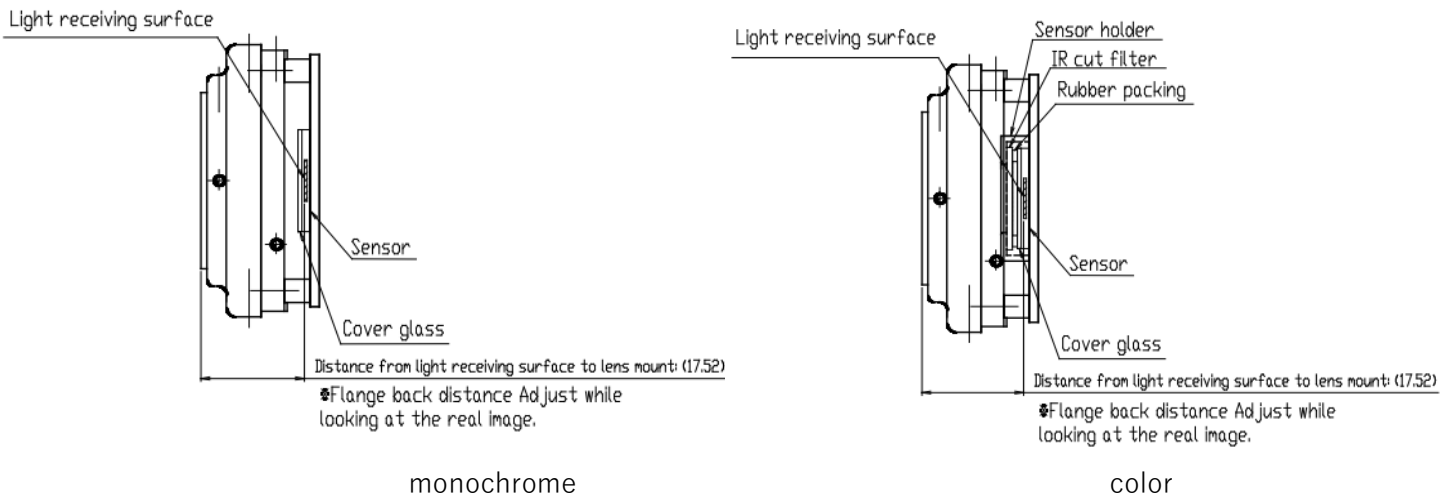

The height of the light receiving surface when the PCB Board pasted is mounted

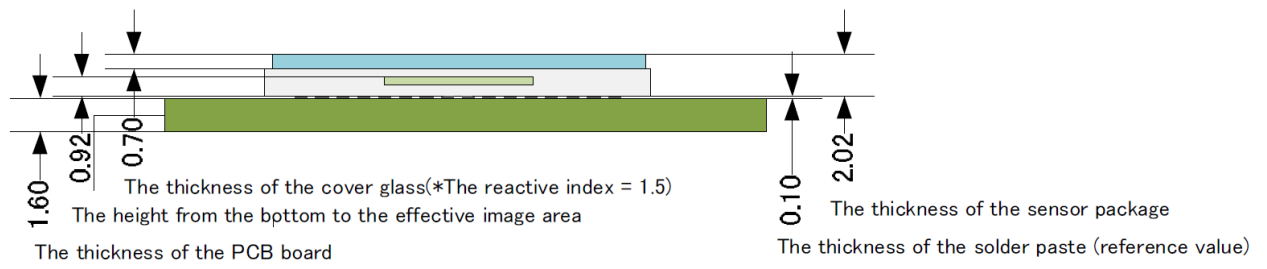

Position Relationship Diagram between the sensor package and the light receiving surface

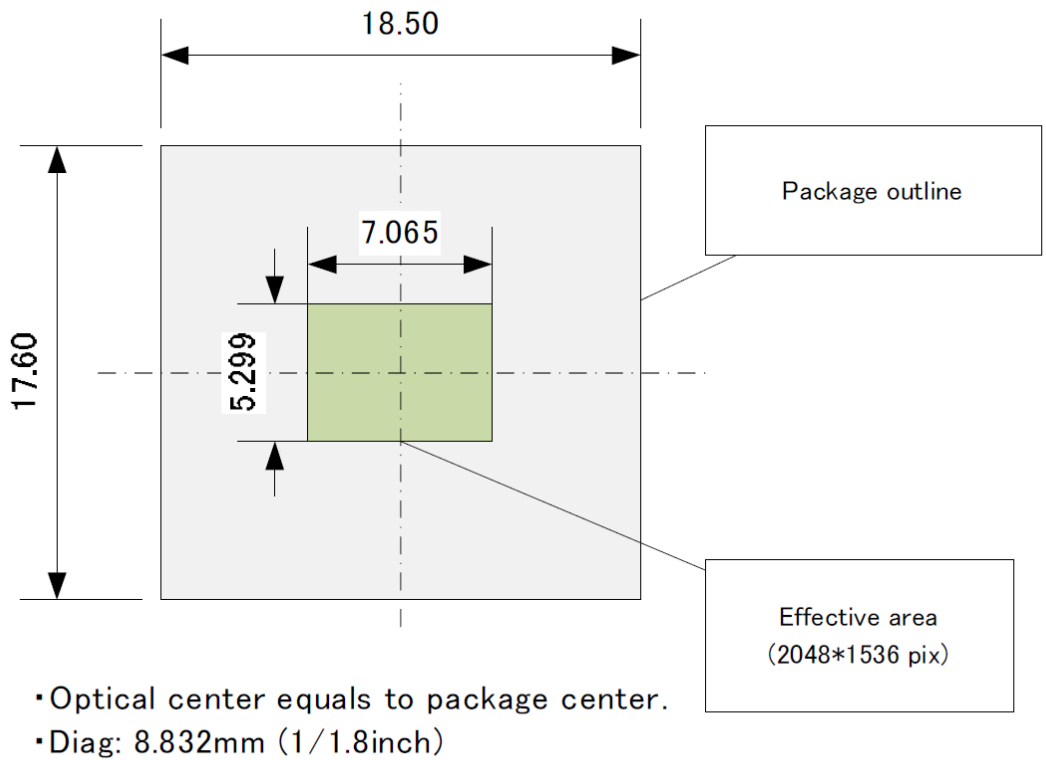

$$H = 3.45[\mu\text{m}] * 2048 = 7065 [\mu\text{m}]$$

$$V = 3.45[\mu\text{m}] * 1536 = 5299 [\mu\text{m}]$$

Field of Vision: Lens versus Sensor (reference value)

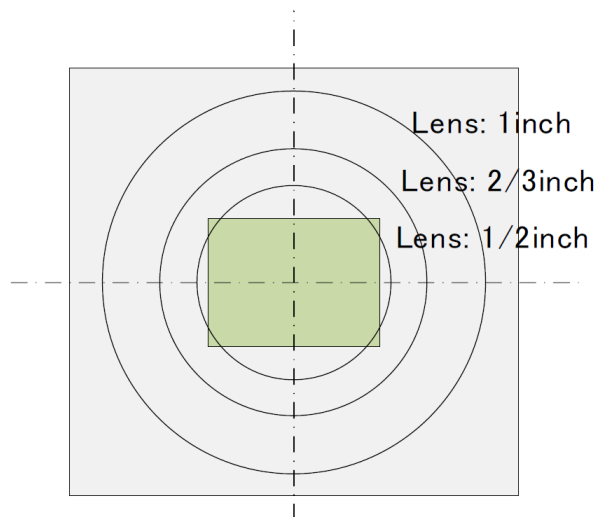

※The ratios of sensor size (diagonal) to lens size in the above illustrations are as follows:

$$1/2 \text{ inch} = \phi 8\text{mm}, 2/3 \text{ inch} = \phi 11\text{mm}, 1 \text{ inch} = 15.8\text{mm}$$

Please note that the actual field of view varies depending on different lens.

8. Spectral Sensitivity Characteristics (Reference Value)

8.1. ARTCAM-265IMX-WOM (color model)

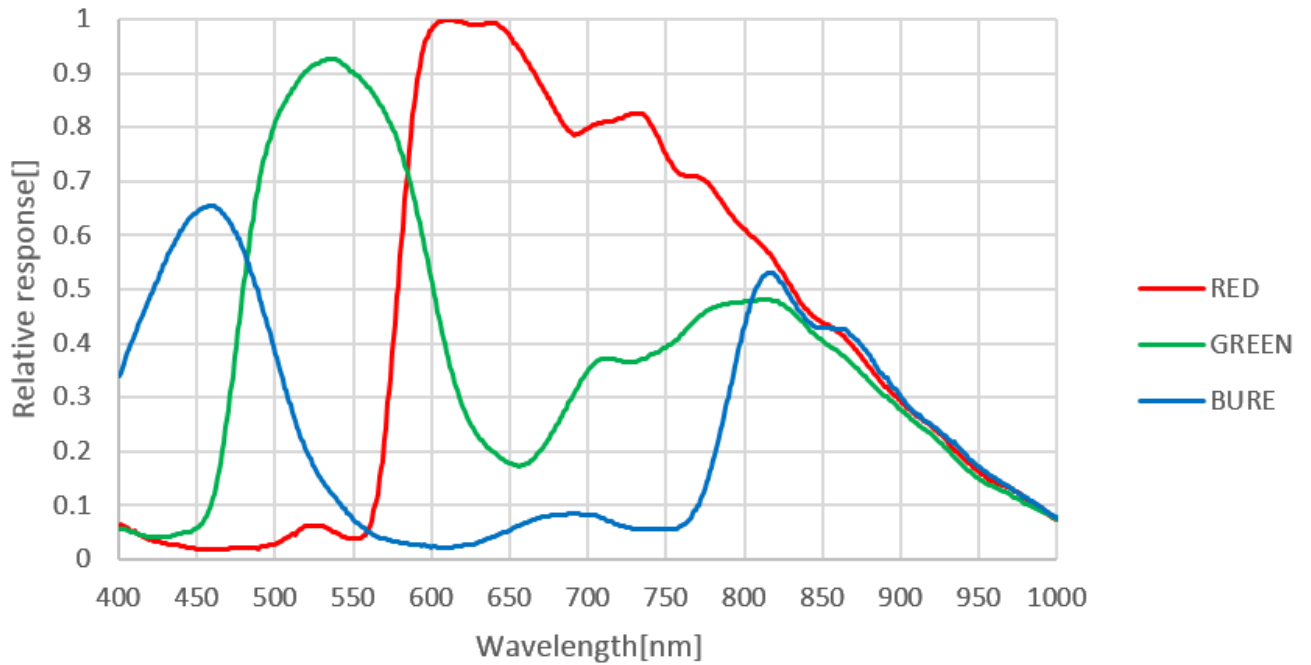

8.2. ARTCAM-265IMX-WOM (Monochrome Model)

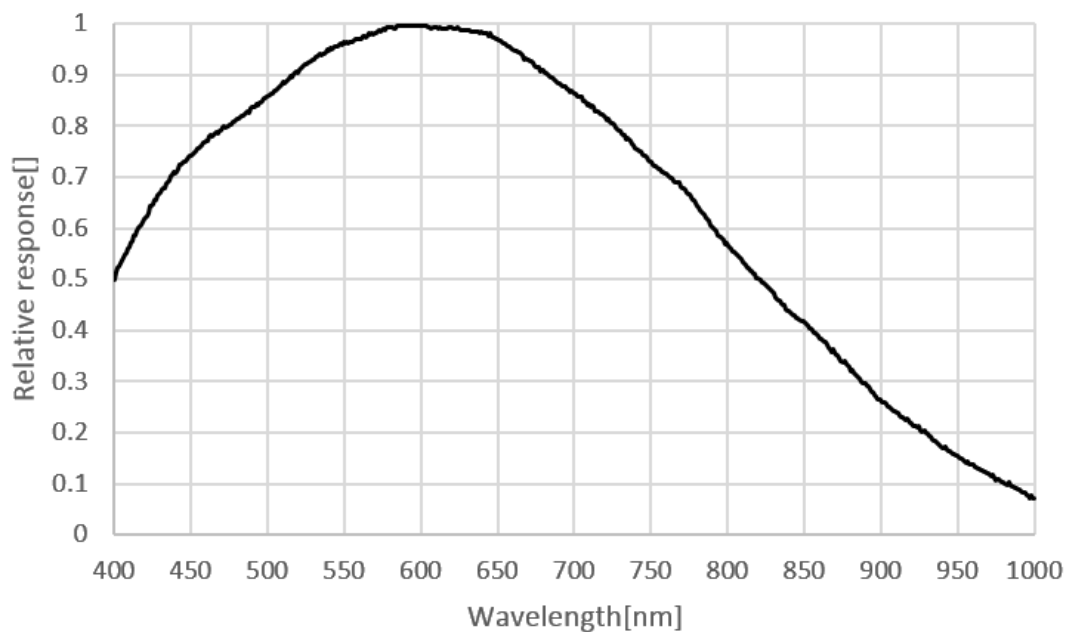

8.3. IR Cut Filter (Color Model only)

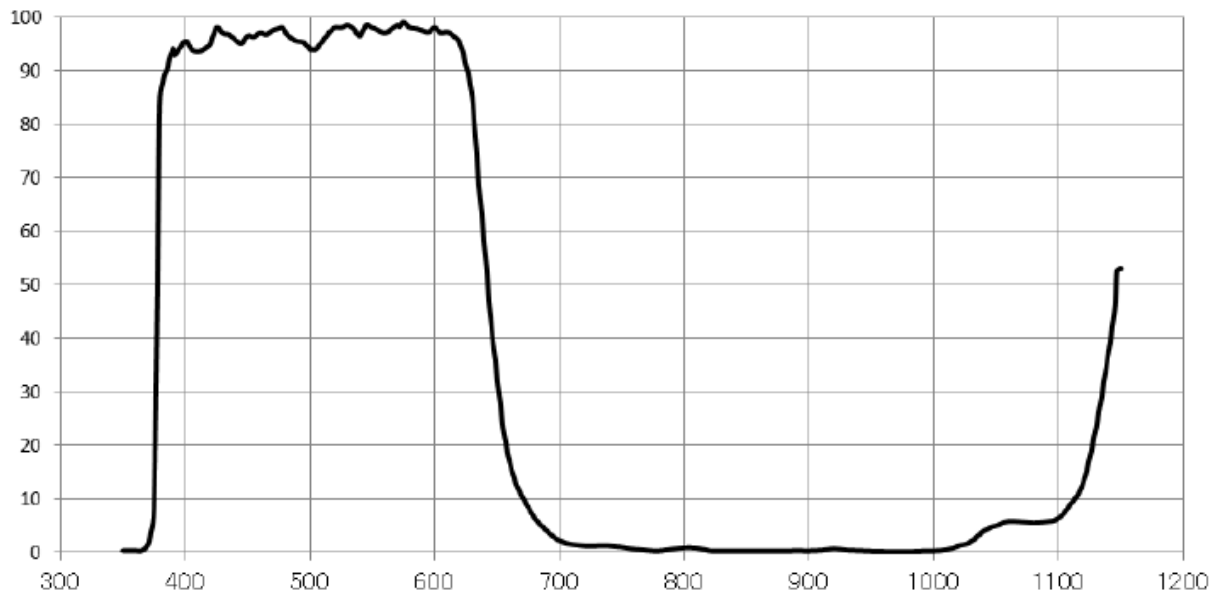

Glass Material: White Board (B270) Reference refractive index 1.52

Thickness: 1.00mm (within a tolerance of ± 0.1 mm)

8.4. Characteristic of Visible Light Cut Filter

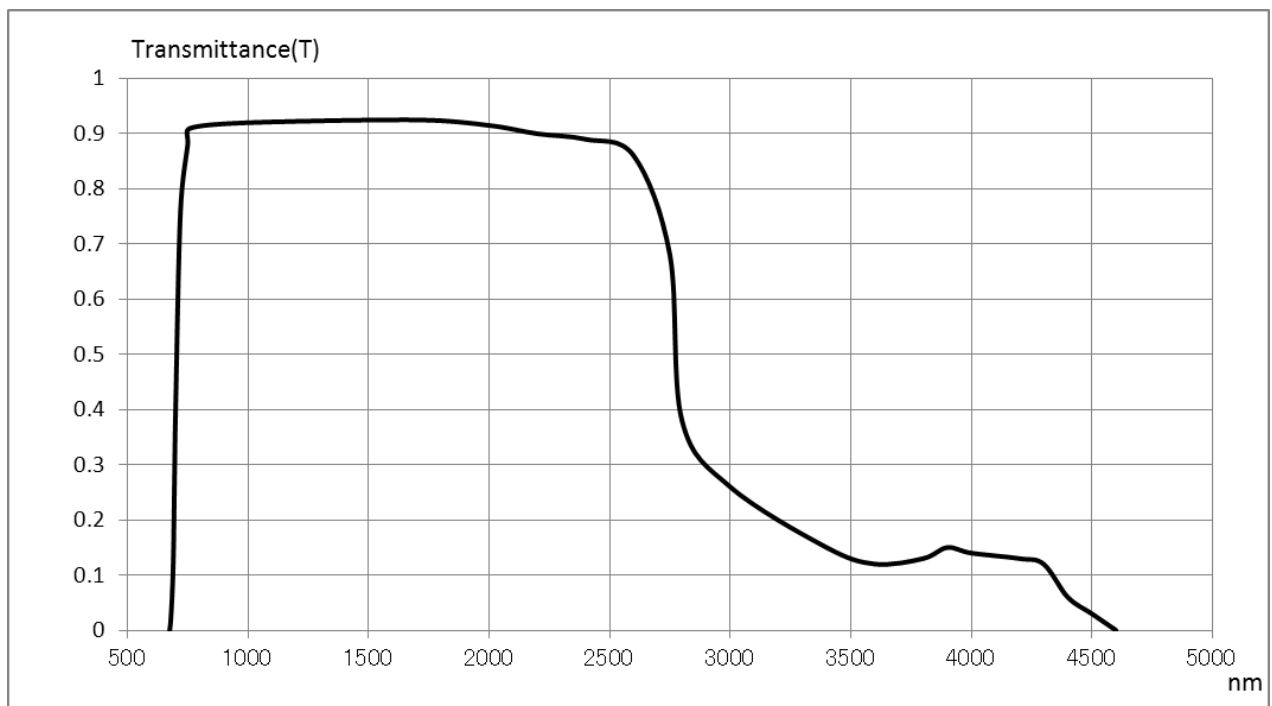

Model Name: R70 Reference refractive index 1.546

Thickness: 2.50mm

9. System Requirements

9.1. Recommended System Requirements

- Host Controller

This camera is applicable to USB 2.0.

- CPU

The driver of this camera is applicable to computer architecture “x86” or “amd64”.

The specification of CPU effects directly the imaging process speed, therefore it is highly recommended to utilize a high-end CPU if possible.

- Memory

In the viewer software, there is a data buffer which can store 4 to 8 frames.

Therefore, it is necessary to keep spare space at least for 8 frames in the memory.

(For example, when using 1.3MP color camera, $1280 \times 1024 \times 3 \times 8$ [byte] = 30[MB] is necessary.)

It is highly recommended to keep enough memory space especially when using high resolution camera.

- OS

This camera is applicable only to the architecture of Windows NT (32bit/64bit).

Standard functions are confirmed with OS after Windows 7.

In addition, it is recommended to use Windows 10.



Caution

■ Please refer the restrictions below when you use ARTCAM series.

(1) Recommended System Requirements

If the system specifications do not meet the requirements recommended above, it may be difficult to run at the maximum frame rate.

(2) Connection of Multiple USB Devices

When connecting multiple USB devices to one USB host controller, some USB device may fail to function stably depending on the specifications of the host controller.

(Problem of power supply, data transfer bandwidth, etc.)

To avoid power supply problem, it is recommended to use powered USB hub.

(3) USB2.0 Cable Extension

We cannot guarantee the functionality of the USB2.0 camera if the user adopts USB2.0 extension cables or repeaters which are not confirmed by us. With the extension cables or repeaters, the bandwidth of transfer may differ, and thus caused malfunctions such as a low frame rate or recognition failure on the camera.

What may cause the problem is that the regulation of the power lines becomes not enough, and so causes impedance mismatch on data signals.

*For the recommended extension cable, please contact our sales department.

(TEL: +81-3389-5488)

ARTRAY CO., LTD. Obtained ISO 9001: 2015 2018/9/17

1-17-5 Kouenjikita, Suginami-ku, Tokyo 166-0002 Japan

Tel: +81-3-3389-5488

Fax: +81-3-3389-5486

Email: sales@artray.us

URL: www.artray.us

ARTRAY